

CHOICE LUMINAIRE FALLING LEAF

NC37-0

warmDIM

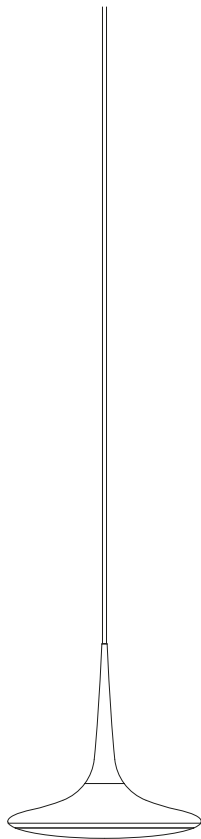

GRAU

Ermittlung der Kabellänge • Determining the length of cable

01 ①

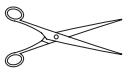
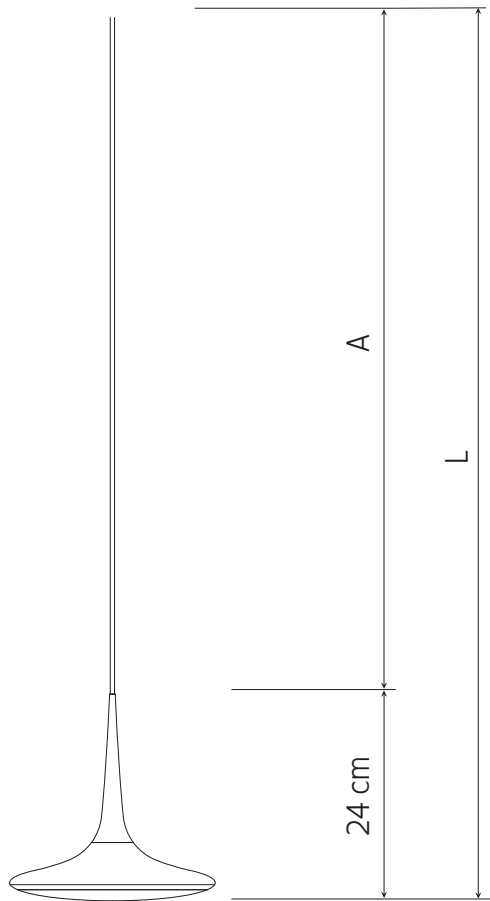

$$L = A + 24\text{cm} + \text{ca. } 8\text{cm}$$

i ①

Montageanleitung • Assembly instructions



01 ②

Zugentlastung fest
einschrauben!

Screw in strain relief
tightly!

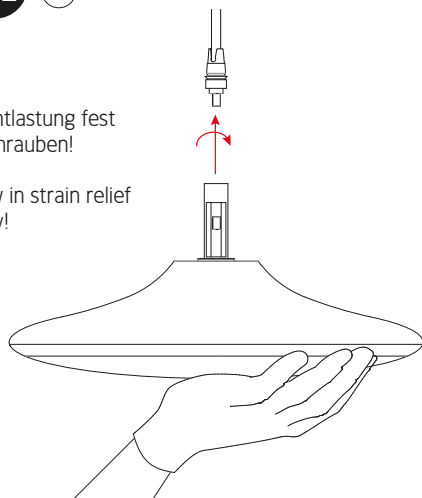

02

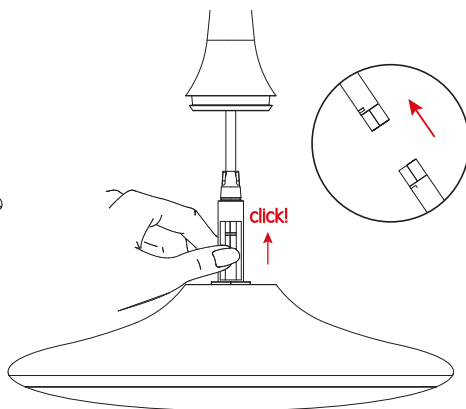

03

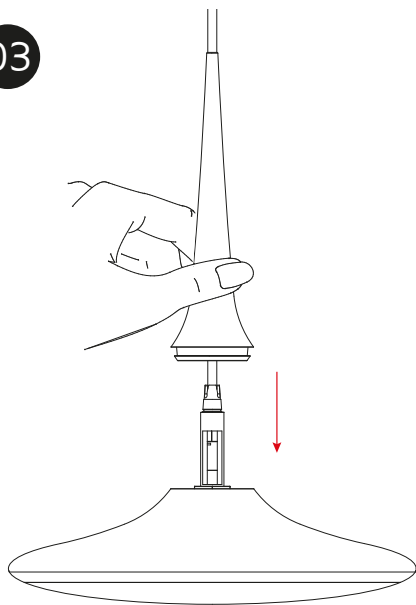

04

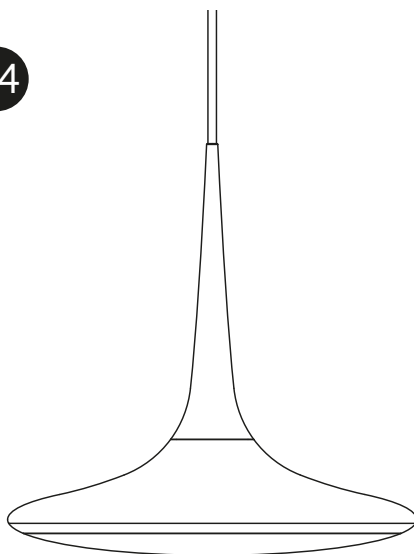

i ②

05

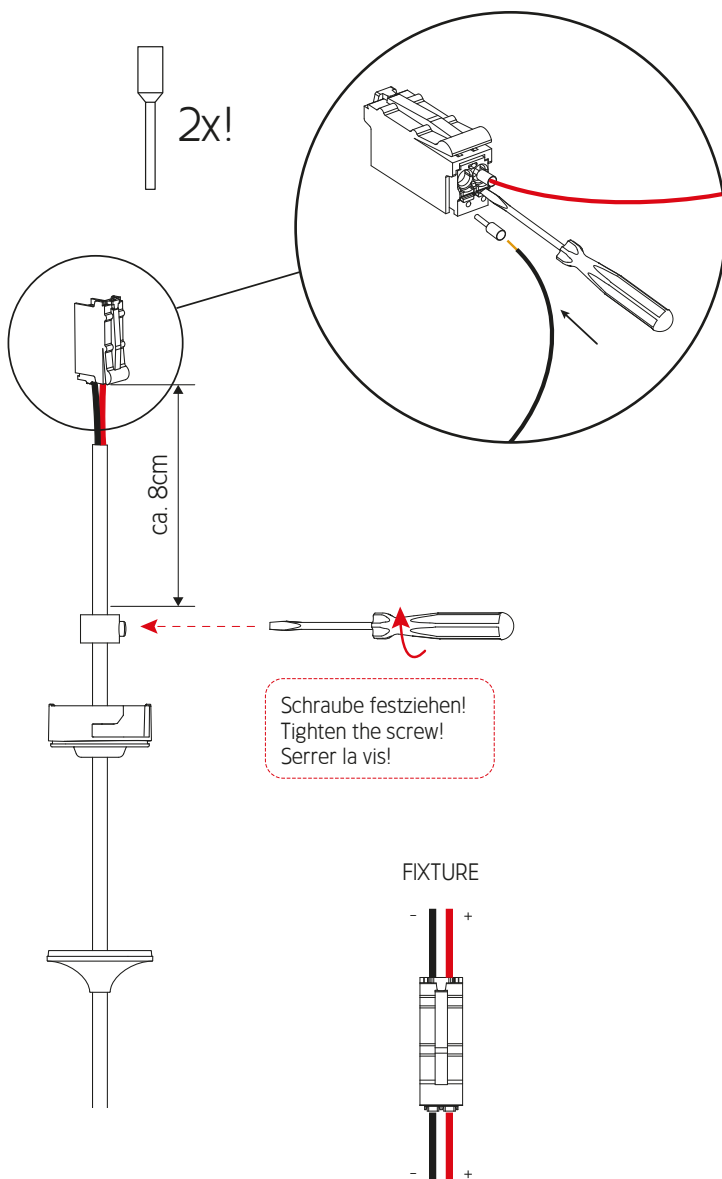

+ = rot / red
- = schwarz / black



Montageanleitung • Assembly instructions

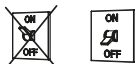

Unbedingt beachten!

Bitte beachten Sie, dass vor Verbindung der Kabel, die Stromversorgung auf der Primärseite getrennt ist, da sonst die LED Schaden nimmt!

Sollte der Konverter bereits ohne Leuchte angeschlossen worden sein oder war die Leuchte verpolt angeschlossen, dann trennen Sie bitte die Stromversorgung auf der Primärseite und warten Sie zwei Minuten, bevor Sie die Sekundärseite wieder anschließen!

Bei nicht beachten entfällt die Garantie!

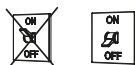

Important!

Before installing this product, ensure power is switched off.

If the converter has first been connected to the power supply, switch the power supply off and wait 2 minutes before connecting to the luminaire.

Failure to do so may damage the LED!!!

A failure to comply will result in a loss of guarantee!

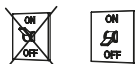

Attention!

Avant de brancher le luminaire, veuillez absolument vous assurer que le courant a été coupé, dans le cas contraire la platine LED subit des dommages.

Si le convertisseur a déjà été mis sous tension, veuillez couper le courant et attendre deux minutes avant de connecter le luminaire au convertisseur.

En cas de non respect de cette clause la garantie ne s'applique pas!

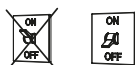

Attenzione!

Prima di collegare il prodotto alla presa di corrente assicurarsi che quest'ultima sia spenta. In caso contrario il LED potrebbe subire dei danni!

Se il convertitore è già stato collegato alla presa di corrente è necessario spegnere quest'ultima e aspettare 2 minuti prima di collegare nuovamente la lampada.

La garanzia decade in caso non si presti attenzione a tale avvertimento!



Montageanleitung • Assembly instructions

06 3 5

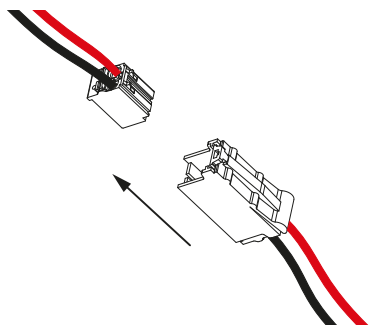

07 4

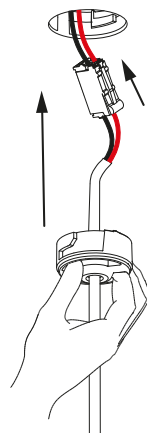

08 6

Über einen spürbaren Widerstand drehen.
Turn past resistance point.

Beim Einsetzen der Leuchte nicht drücken.
Do not push while inserting the bayonet adapter.

Nicht in die falsche Richtung drehen.
Do not turn in the wrong direction.

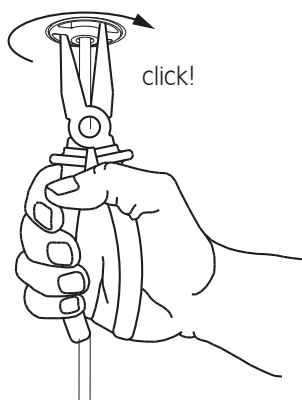

09 7 8 9

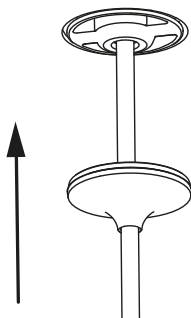

i 3 4 5 6 7 8 9

01

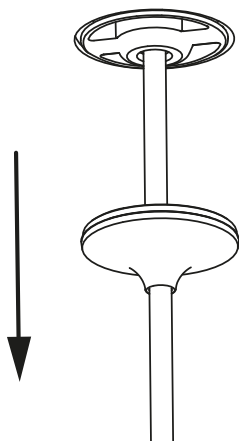

02

Über einen spürbaren Widerstand drehen.
Turn past resistance point.

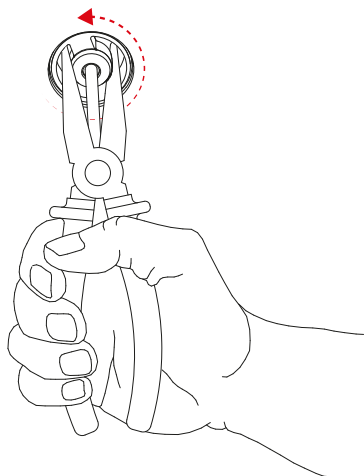





i



DEUTSCH

- ① Die Ware muss vor Montage auf optische Fehler bzw. Kratzer überprüft werden. Mit der Montage erlischt der Reklamationsanspruch auf optische Mängel der Ware.
- ② Bitte lassen Sie die Montage von einem Elektrofachbetrieb durchführen.
- ③ Auf die Polung der Kabellitzen achten!
- ④ Nicht die Kabel einklemmen!
- ⑤ Bitte verwenden Sie für den Betrieb der Leuchte ausschließlich die von uns angebotenen Vorschaltgeräte. Die Leuchte kann bei Montage an einem nicht passenden Vorschaltgerät Schaden nehmen, dafür kann keine Garantie übernommen werden.
- ⑥ Bitte achten Sie darauf, dass Sie die integrierte Drehbegrenzung nicht überdrehen!
- ⑦ **Oberflächenschutz:**
Alle polierten, lackierten oder galvanisch veredelten Oberflächen sind vor Belastungen jeglicher Art zu schützen – insbesondere alle Kupferteile, welche nur mit einem unsichtbaren Anlaufschutz versehen sind.
- ⑧ Bitte die Leuchte ausschließlich mit einem trockenen Tuch reinigen. Wir empfehlen Microfasertücher für empfindliche Oberflächen. Das Reinigen muss in abgekühltem Zustand erfolgen.
- ⑨ Abweichungen bei der Helligkeit und dem Weißton der verwendeten LEDs sind herstellungsbedingt und kein Grund für eine Beanstandung.

CHOICE LUMINAIRE LEAF	
	Schutzklasse 3
	Dieses Produkt enthält eine Lichtquelle der Energieeffizienzklasse D. Diese kann nur vom Hersteller ausgetauscht werden.
	SEC 500mA / 16W
	73/23/EWG 89/336/EWG





GARANTIE:

Sie haben ein hochwertiges Produkt erworben, welches mit Sorgfalt produziert und verpackt worden ist. Sollten Sie dennoch einmal Grund zur Beanstandung haben, wenden Sie sich bitte ausschließlich an Ihren Händler. Geben Sie bitte die auf der letzten Seite genannte Endkontrollnummer bei Ihrer Reklamation an. Ihre Reklamation wird bei uns im Hause umgehend bearbeitet. Bitte haben Sie Verständnis, dass eine Garantie unsererseits nur bei sachgemäßer Montage übernommen werden kann - wir empfehlen daher Fachbetriebe.



ENGLISH

- ① The products must be checked for visual defects, and/or scratches, prior to assembly. Once the product has been assembled, the right for a customer to make a complaint due to visual defects expires.
- ② Please have a qualified electrical specialist carry out the installation.
- ③ Pay attention to the polarity of the cable strands!
- ④ Don't jam the cables!
- ⑤ When operating this luminaire, please only use the ballasts which are exclusively offered by us. The luminaire can be damaged when mounted to a non-matching ballast and is something that our guarantee does not cover.
- ⑥ Please do not overtighten the integrated movement limiter!
- ⑦ Surface protection:
All polished, lacquered or galvanised surfaces have to be protected against all types of stresses – especially all copper parts, as they are only provided with an invisible protection against tarnishing.
- ⑧ Please clean the lamp with a dry cloth. We recommend microfibre cloths for sensitive surfaces. Only clean the lamp after it has cooled down.
- ⑨ Differences in brightness and white tone of the LED's are conditional of manufacturing and are no reason for a complaint.

CHOICE LUMINAIRE LEAF	
	Protection class 3
	This product contains a light source of energy efficiency class S. The LEDs can be replaced by the producer only.
	SEC 500mA / 16W
	73/23/EWG 89/336/EWG





GUARANTEE:

You have purchased a high-quality product that was produced and packaged with the utmost care. Should you nevertheless have grounds for complaint, please contact your retailer quoting the final inspection number as stated on the last page of this document. We will deal with your complaint immediately. This warranty applies only to products that have been fitted appropriately – we therefore recommend fitting by qualified personnel.



FRANÇAIS

- ① Avant tout montage, veuillez vérifier que le luminaire ne présente aucun défaut apparent (p.ex. rayures). Aucune réclamation ne peut être acceptée après montage.
- ② Merci de contacter un spécialiste agréé en électricité pour le montage.
- ③ Veuillez faire attention à la bonne polarité des câbles!
- ④ Ne pas coincer les câbles!
- ⑤ Merci d'installer le luminaire uniquement avec un convertisseur de notre gamme. Nous déclinons toute responsabilité quant aux dégâts éventuels résultant d'une mise en service avec un convertisseur non-approprié.
- ⑥ Veuillez faire attention à ce que la butée de mouvement intégrée ne soit pas forcée !
- ⑦ Protection de la surface :
Toutes les surfaces polies, laquées ou galvanisées doivent être protégées des moindres sollicitations mécaniques ou chimiques, en particulier les pièces en cuivre, étant uniquement protégées par un traitement non - visible antioxydant.
- ⑧ Veuillez nettoyer le luminaire uniquement avec un tissu sec. Nous conseillons des tissus micro pour surfaces sensibles. Le nettoyage doit s'effectuer lorsque le luminaire est froid.
- ⑨ Des différences de clarté et de couleur des blancs des LED sont liées à la production et ne donnent pas lieu à réclamation.

CHOICE LUMINAIRE LEAF	
	Classe de protection 3
	Ce produit contient une source lumineuse de classe d'efficacité énergétique D. Les LED intégrés dans le luminaire ne peuvent être remplacés que par le fabricant.
	SEC 500mA / 16W
	73/23/EWG 89/336/EWG





GARANTIE:

Vous venez de faire l'acquisition d'un produit de haute qualité, fabriqué et emballé avec le plus grand soin. Si, malgré le soin apporté, vous êtes amené à rencontrer un problème, merci de contacter exclusivement votre revendeur en indiquant le numéro de contrôle qui se trouve en dernière page. Notre société donnera suite sans tarder à votre réclamation. Vous comprenez aisément que nous ne pouvons assurer de garantie que dans le cas où le montage du matériel a été effectué correctement - par conséquent, nous vous recommandons de vous adresser à un spécialiste.



ITALIANO

- ① Il prodotto deve essere controllato prima dell'assemblaggio. Difetti visuali/graffi, se riscontrati, devono essere segnalati prima di installare la lampada, altrimenti il cliente non avrà più diritto al reclamo.
- ② Per favore fate eseguire l'installazione da un elettricista.
- ③ Attenzione ai poli diversi!
- ④ Non schiacciare i cavi!
- ⑤ Per un corretto funzionamento della lampada, vi preghiamo di utilizzare solo i trasformatori da noi offerti. Se l'installazione ad un apparecchio non adeguato causa danni alla lampada, questa perderà la garanzia.
- ⑥ Fate attenzione a non sforzare la lampada attraverso un movimento oltre il limite di arresto.
- ⑦ Protezione delle superfici :
Tutte le superfici trattate con lucidatura, lacca o in bagni galvanici, sono da proteggersi da qualsiasi tipo di sollecito, in particolare quelle in rame, che hanno solo un sottile film contro la colorazione nel tempo.
- ⑧ Per favore pulire la lampada esclusivamente con un panno asciutto. Si consiglia di utilizzare tessuti in microfibra. Le lampade devono essere fredde durante la pulizia.
- ⑨ Differenze in luminosità e nella tonalità bianca dei LED utilizzati sono dovute alla fabbricazione e non costituiscono motivo di reclamo.

CHOICE LUMINAIRE LEAF	
	Classe di sicurezza 3
	Questo prodotto contiene una sorgente luminosa di classe di efficienza energetica D. I LEDs possono essere cambiati esclusivamente dal produttore.
	SEC 500mA / 16W
	73/23/EWG 89/336/EWG

GARANZIA:

Avete deciso di acquistare un prodotto d'alto valore, prodotto ed imballato con accuratezza. Se ci fossero ragioni per un reclamo, vi preghiamo di rivolgervi esclusivamente al vostro rivenditore di fiducia. Per favore indicate per chiarezza il numero di controllo stampato sull'ultima pagina. Il vostro reclamo sarà elaborato presso di noi. Considerate che da parte nostra possiamo assumere la garanzia del prodotto soltanto nel caso in cui il montaggio avvenga a regola d'arte: consigliamo dunque di rivolgersi ad aziende d'installazione specializzate.

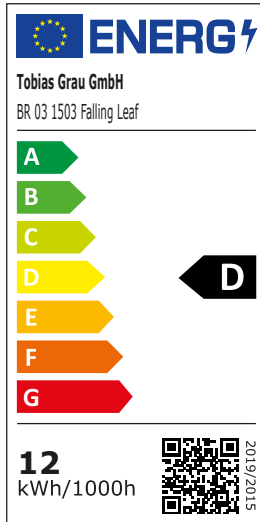

Endkontrollnummer	2 Jahre Garantie 5 Jahre Garantie auf die LED
Final inspection number	2 years guarantee 5 years guarantee of LED
Numéro de contrôle final	2 ans de garantie 5 ans de garantie sur les LED
Numero di controllo finale	2 anni di garanzia 5 anni di garanzia per i LED

